

- preference version -

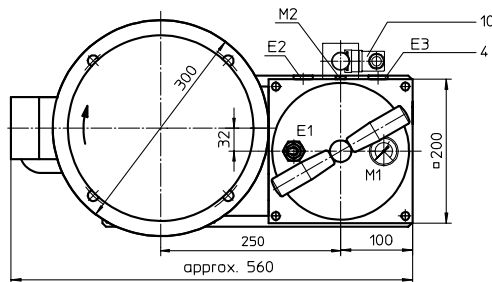
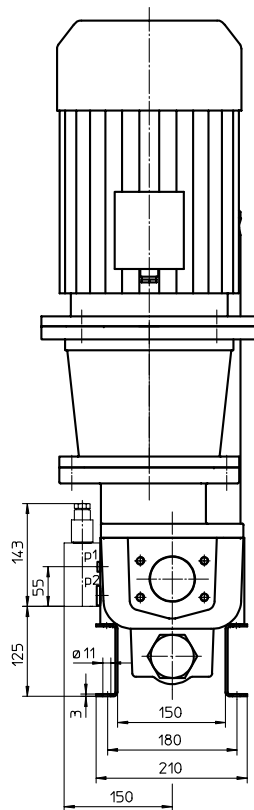
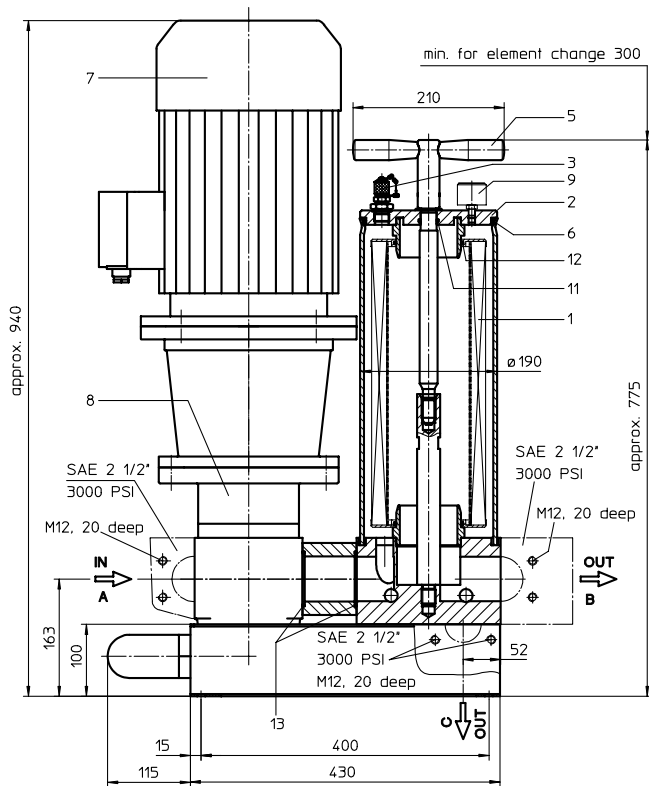

Assignment of connections and functions:

- E1: venting mini-measuring connection, MA.1.St see sheet-no.1650
- E2: drainage of filter, dirt side
- E3: drainage of filter, clean side
- M1: measure connection in the housing cover, dirt side
- M2: measure connection at filter housing
- p₁ = dirt side
- p₂ = clean side

Notice:

Only operate all motors listed on this data sheet in combination with the pump unit specified on the type plate under item 8.

FILTER UNIT, stationary
Series US 321

Sheet No. **4012.2 E**
Sheet 2/2

1. Type index:

1.1. Filter unit: (ordering example)

US. 321. 6VG. 10. B. P. -. P07. D07. 3. O. AE

1	2	3	4	5	6	7	8	9	10	11	12
---	---	---	---	---	---	---	---	---	----	----	----

- 1 **series:**
US = filter unit, stationary
- 2 **nominal size:** 321
- 3 **filter-material and filter-fineness:**
10 VG = 10 µm_(c), 6 VG = 7 µm_(c), 3 VG = 5 µm_(c), 1 VG = 4 µm_(c) Interpor fleece (glass fibre)
10 WVG = 10 µm_(c), 3 WVG = 5 µm_(c) Watersorp-filter element
- 4 **resistance of pressure difference for filter element:**
10 = Δp 10 bar
- 5 **filter element design:**
B = both sides open
- 6 **sealing material:**
P = Nitrile (NBR), V = Viton (FPM), by agreement
- 7 **filter element specification:**
- = standard, VA = stainless steel, IS06 = see sheet-no. 31601
- 8 **pump unit:**
P07 = pump unit 07, NG 320.200 (standard-pump-unit / setting range 4-8 bar)
- 9 **motor: (D = rotary current motor)**

motor	electrical connection	volume flow	max. viscosity	max. pressure	on/off switch	cable	doc.-no.
D07 ¹⁾	400/690V	50Hz	284,0 l/min	10-400 mm ² /s	4 bar	-	34378-4
D07 ¹⁾	460/790V	60Hz	340,0 l/min	10-400 mm ² /s	4 bar	-	34378-4
D22	400/690V	50Hz	190,0 l/min	10-800 mm ² /s	6 bar	-	34486-4
D22	460/790V	60Hz	228,0 l/min	10-800 mm ² /s	6 bar	-	34486-4

¹⁾ standard motor

10 **connection variant:**

variant	connection A		connection B		connection C	
	type	size	type	size	type	size
3	FS	9	FS	9	-	-
4	FS	9	FS	9	FS	9

type: FS = flange SAE 3000 PSI

size: 9 = 2 1/2"

- = no connection

11 **clogging indicator at M1:**

- = without
- O = visual, 2,5 bar

12 **clogging indicator at M2:**

- = without
- AOR = AOR.2.5..., visual, at p₁ and p₂, 2,5 bar, see sheet-no. 1606
- AOC = AOC.2.5..., visual, at p₁ and p₂, 2,5 bar, see sheet-no. 1606
- AE = AE30.2.5... electrical at p₁ and p₂, 2,5 bar, see sheet-no. 1609
- OP = OP.2.5..., visual, at p₁ and p₂, 2,5 bar, see sheet-no. 1628
- OE = OE.2.5..., visual-electrical, at p₁ and p₂, 2,5 bar, see sheet-no. 1628
- E1 = E1.2.5 electrical at p₁, 2,5 bar, see sheet-no. 1616
- E5 = E5.2.5 electrical at p₁, 2,5 bar, see sheet-no. 1616

1.2. Filter element: (ordering example)

01NR. 1000. 6VG. 10. B. P. -

1	2	3	4	5	6	7
---	---	---	---	---	---	---

- 1 **series:**
01NR. = standard-return-line filter element according to DIN 24550, T4
- 2 **nominal size:** 1000
- 3 - 7 see type index-filter unit

Changes of measures and design are subject to alteration!



Friedensstrasse 41, 68804 Altlusheim, Germany

phone +49 - (0)6205 - 2094-0 e-mail sales@internormen.com
fax +49 - (0)6205 - 2094-40 url www.internormen.com



2. Spare parts:

item	designation	qty.	dimension	article-no.
1	filter element	1	01NR. 1000	
2	housing cover	1	22496-3	313837
3	mini-measuring connection	1	MA.1.St	305453
4	screw plug	2	G ½	304678
5	straining screw	1	31067-3	316893
6	O-ring	1	170 x 6	304799 (NBR)
7	electric motor	1	according to type index	
8	pump unit P07	1	NG 320.200	316908
9	clogging indicator (series)	1	visual Ø 40	315452
10	clogging indicator	1	according to type index	
11	O-ring	1	22 x 3	304387 (NBR)
12	O-ring	2	90 x 4	306941 (NBR)
13	O-ring	2	69,45 x 3,53	305868 (NBR)

3. Description:

The stationary filter unit is intended for oil maintenance on hydraulic systems.

The area of application comprises:

- secondary flow filtration in addition to the existing operating filter
- secondary flow filtration without the action of the operating filter
- filtration when filling the oil reservoir.

The filter unit must not be used to pump contaminated hydraulic fluids and is therefore designed without a switchover fitting to by-pass the filter. The compact structural design on a base plate without pipe satisfies the prerequisites for small dimensions and high reliability.

The device is equipped with a gear pump driven by an E-motor. The flow conveyed by the geared pump is fed over a filter element to DIN 24550, T4, nominal size 1000.

Depending on the customer's wishes, the filter fineness is either 4, 5, 7 or 10 µm_(c). The contamination level of the filter element can be read off from a pressure display in the cover of the filter.

At a pressure >2,5 bar (red area of the scale field), the filter element is contaminated and it must be replaced with a new filter element.

The filter element can be changed without tools. After removing the straining screw and taking off the housing cover, the filter element is accessible and it can be exchanged. The filter elements are supplied complete with seals. Since it is not possible to clean the elements, the user must always keep an adequate supply of spare elements in stock.

To protect against overpressure, the filter unit is fitted with a safety valve. The initial response pressure difference valve is set according to pressure stated in the table on the type plate under item 9. If a different pressure setting is requested, please state the initial response pressure with respect to the set pressure range of the pump unit in the plain text when ordering.

Stationary filter units with motors without combined protective motor switch and ON/OFF switch and without any cable with plug (see switch „-“, cable „-“ under item 9 of the type plate) can be operated without supervision if the electrical connection is fitted with an overload protection corresponding to the current consumption of the selected E-motor and if the switch-off function of the E-motor of the electrical clogging indicator is disengaged at 2,5 bar.

The line, venting and draining connections are identified according to their function. Drainage is necessary when cleaning the filter unit in connection with the change of filter element, and when setting the medium.

4. Technical data:

filter-fineness:	4, 5, 7 or 10 µm _(c)
weight:	approx. 125 kg
operating medium:	hydraulic oil based on mineral oil from 10 mm ² /s, other media on request

Classified under the Pressure Vessel Directive 97/23/EC for mineral oil (fluid group 2), Article 3, Para. 3.
Classified under ATEX Directive 94/9/EC according to specific application (see questionnaire sheet-no. 34279-4).

5. Symbols:

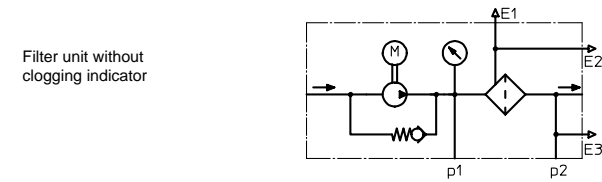

Filter unit with electrical clogging indicator AE30

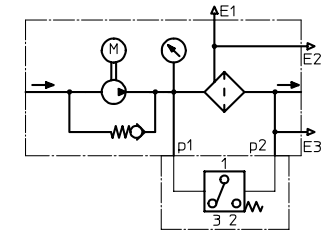

Filter unit with visual clogging indicator AOR, AOC, OP

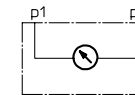

Filter unit with visual-electrical clogging indicator OE1

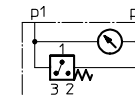

Filter unit with visual-electrical clogging indicator OE2

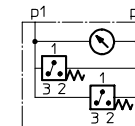

Filter unit with electrical clogging indicator contact maker E1

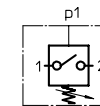

Filter unit with electrical clogging indicator contact breaker E5

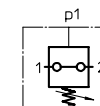

6. Test methods:

Filter elements are tested according to the following ISO standards:	
ISO 2941	Verification of collapse/burst resistance
ISO 2942	Verification of fabrication integrity
ISO 2943	Verification of material compatibility with fluids
ISO 3723	Method for end load test
ISO 3724	Verification of flow fatigue characteristics
ISO 3968	Evaluation of pressure drop versus flow characteristics
ISO 16889	Multi-pass method for evaluating filtration performance